

Article number: 20956604
 Description: E+GLEvelling foot
 GN 342.2-40-M12-63-SV

Measures

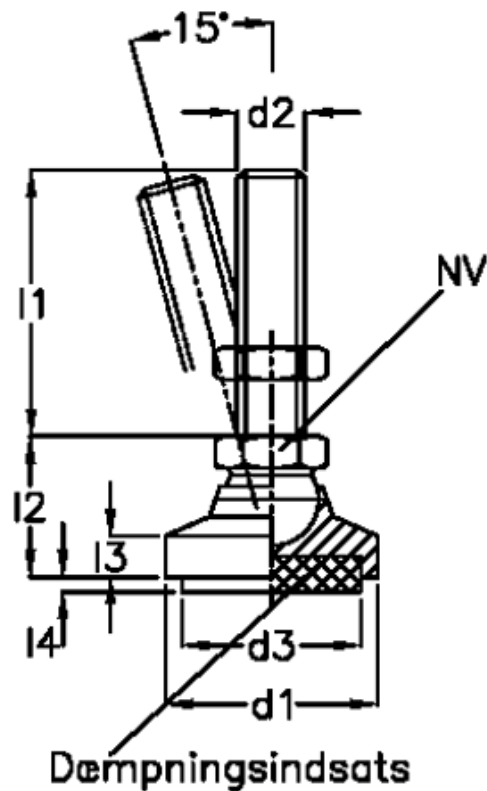

Area(m ²) damping insert = 1134	l ₄ compression 0.4 N/mm ²	= 4.8
d ₁ = 40	l ₄ compression 0.6 N/mm ²	= 3.9
d ₂ = M12	Load (N) by compression 0.4 N/mm ²	= 450
d ₃ = 38	NV	= 18
l ₁ = 63	t	= 11.5
l ₂ = 30.0		
l ₃ = 9.5		
l ₄ compression 0 N/mm ² = 6.0		